

5

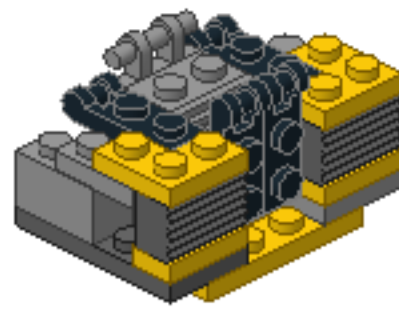

6

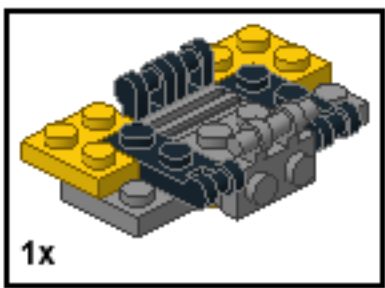
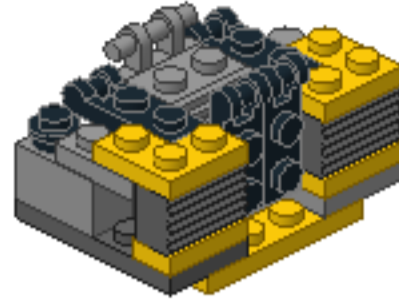

7

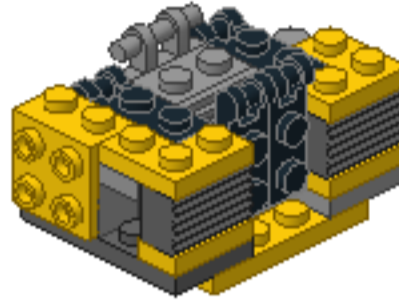

8

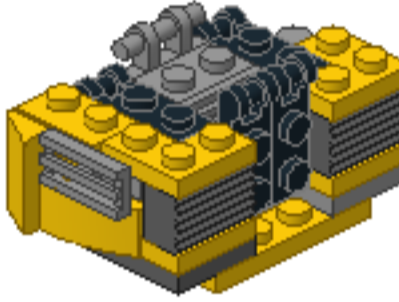
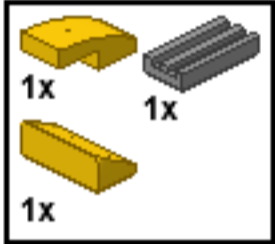

9

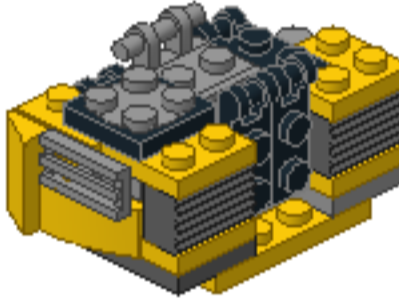
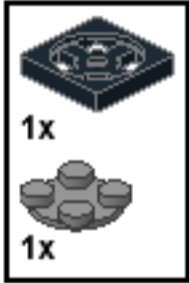

1



2



3





1



2

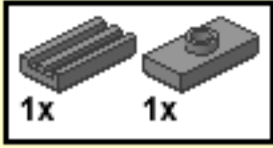

14

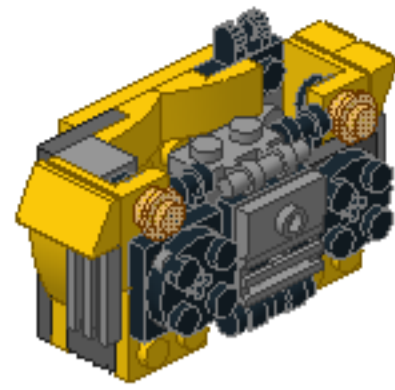

1



2

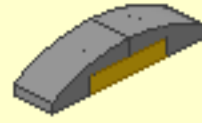







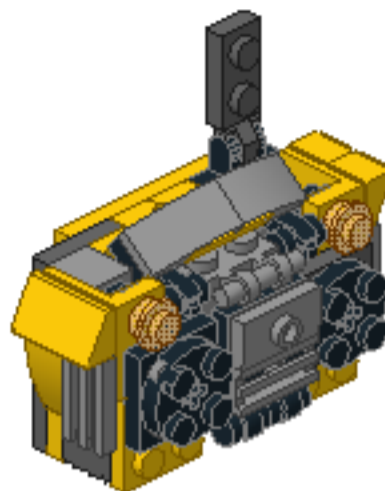
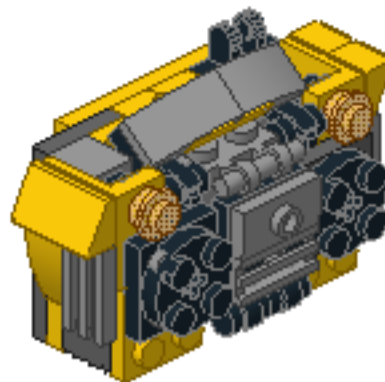
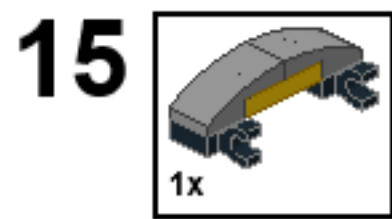





















3







-  2x
-  1x
-  1x
-  1x
-  2x
-  1x
-  2x
-  1x
-  4x
-  1x
-  3x
-  2x
-  1x
-  1x
-  3x
-  1x
-  4x
-  2x
-  2x
-  2x
-  1x
-  1x
-  2x
-  2x
-  1x
-  2x
-  3x
-  4x