

1

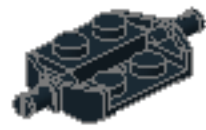

1

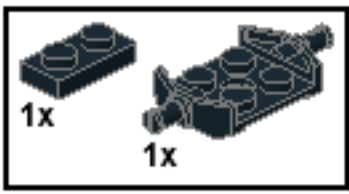
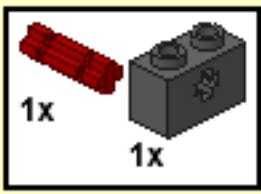

2



2



3

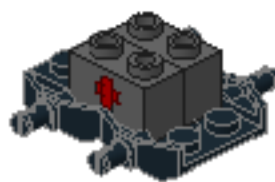
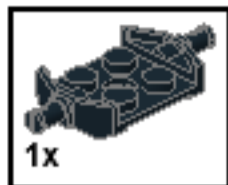

4

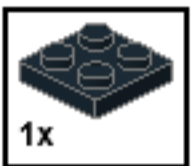

5

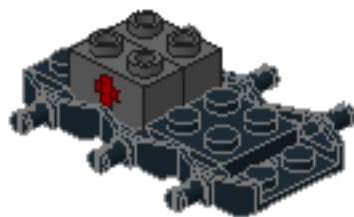
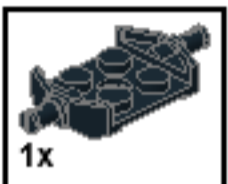

6

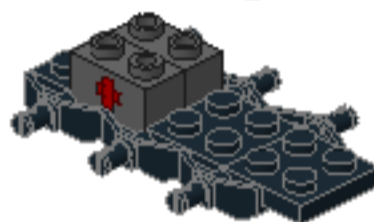
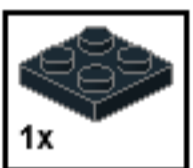

7

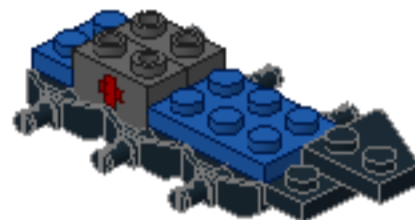
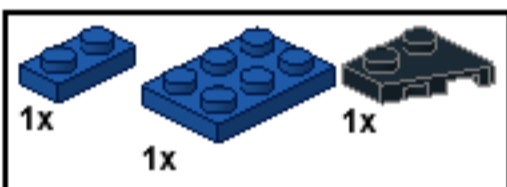

8

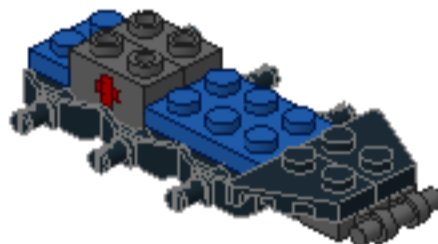
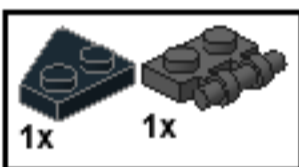

9

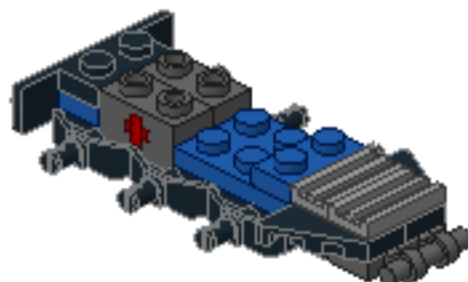
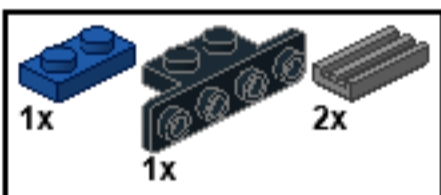

10

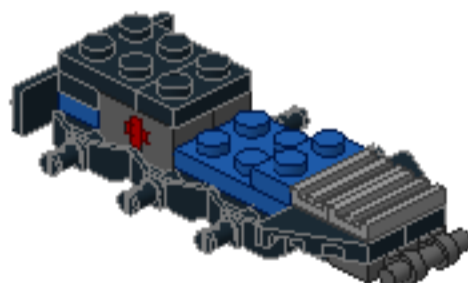
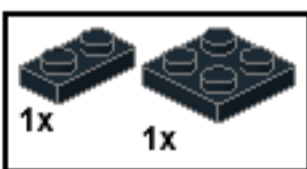

11

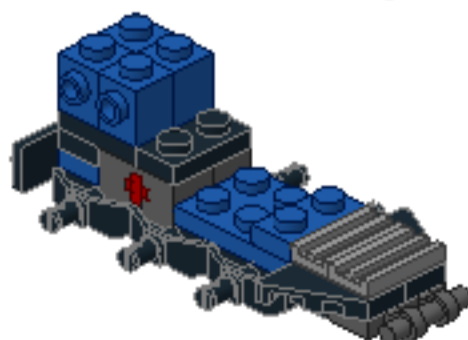

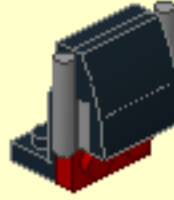
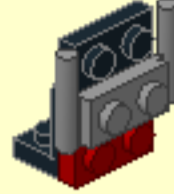
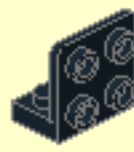
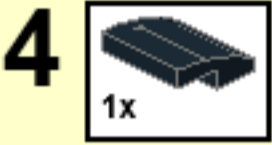
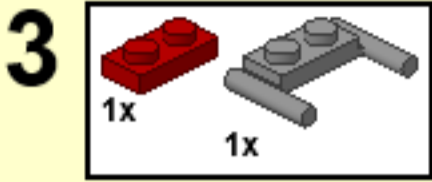

12

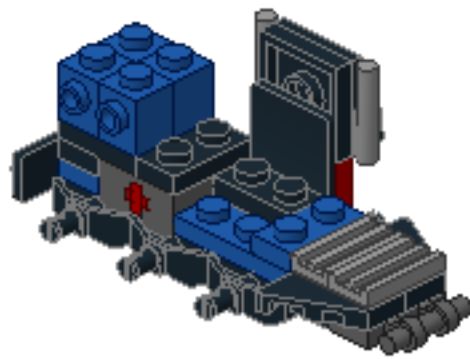
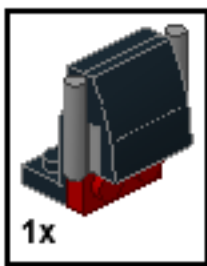

13

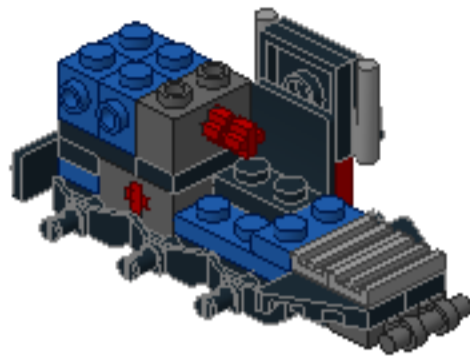
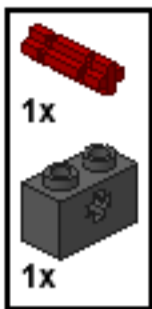

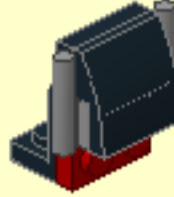
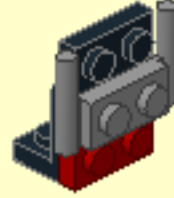
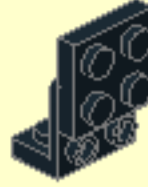
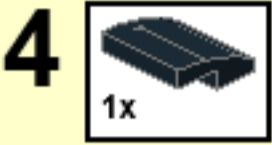
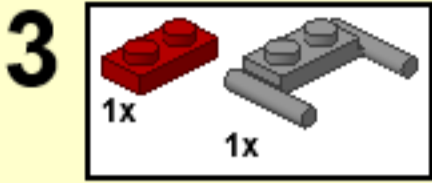

14

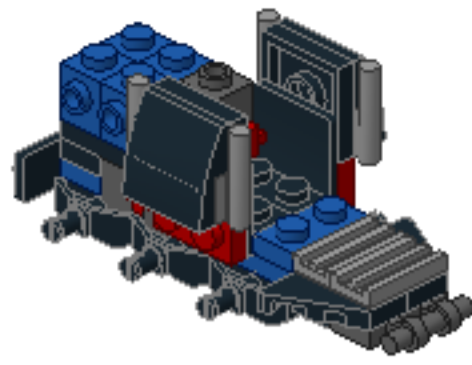
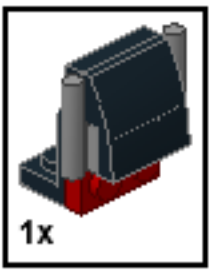

15

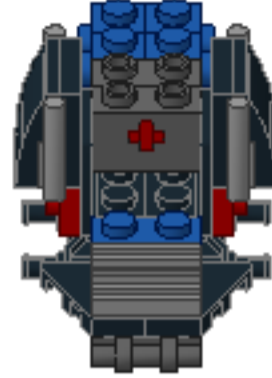
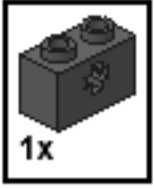

16

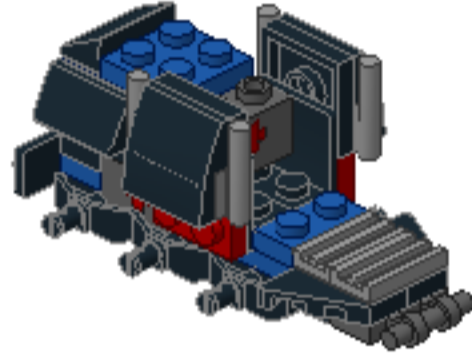
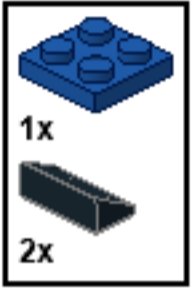

17

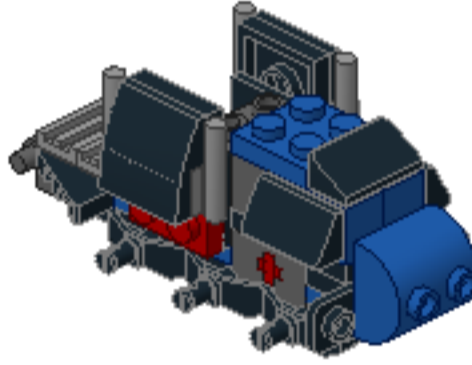
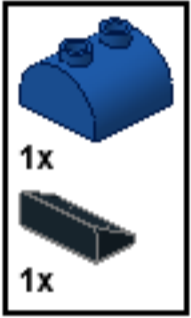

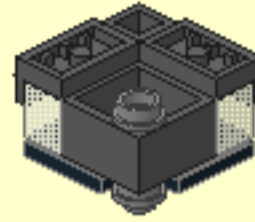
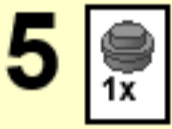
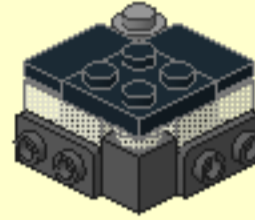
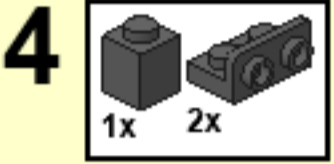
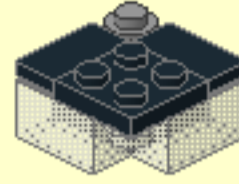
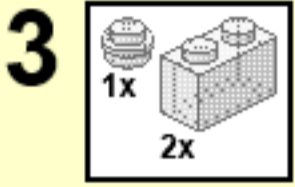
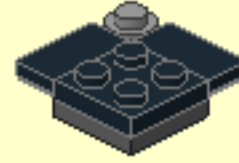
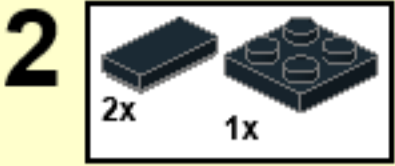
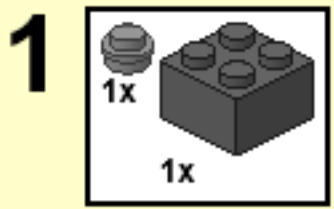



18

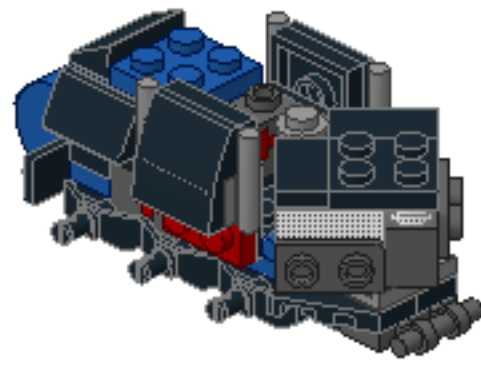
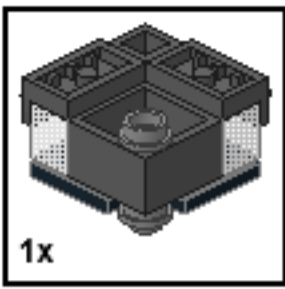

19

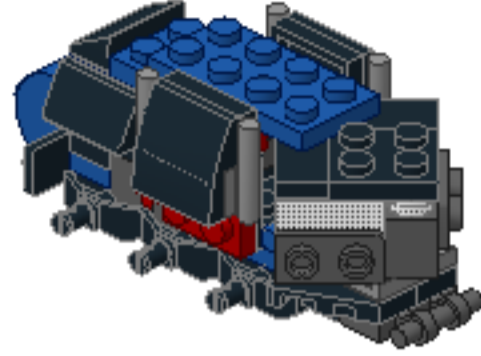
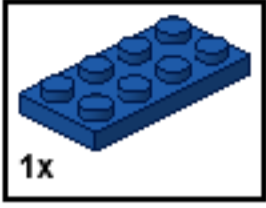

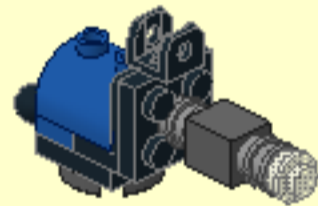
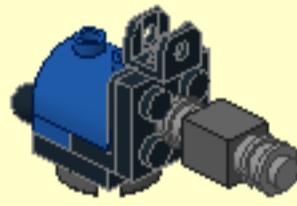
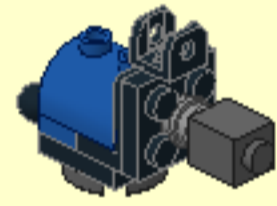
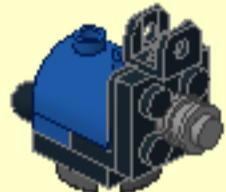
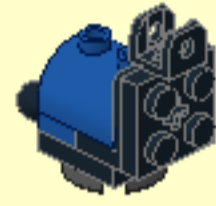
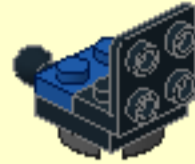
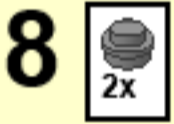
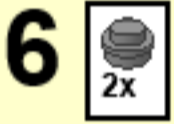

20

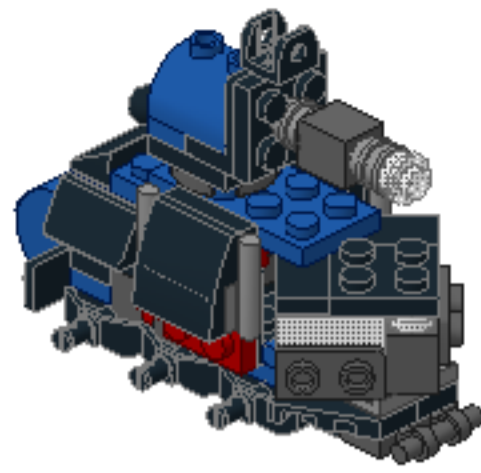
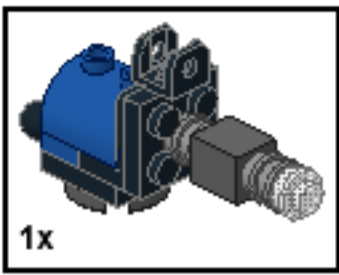



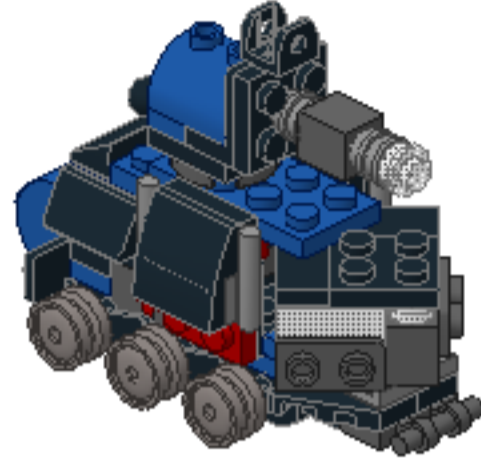



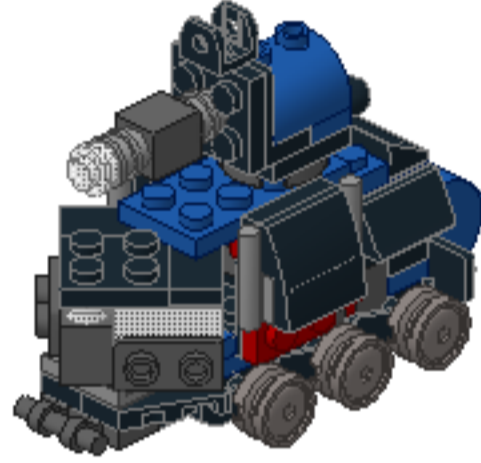









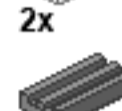









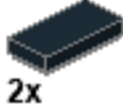





21



22



- |  |   |
|--|---|
|     |     |
| 2x   | 2x  |
|    |    |
| 2x   |   |
|    |    |
| 1x   | 1x  |
|    |    |
| 1x   | 2x  |
|    |    |
| 4x   | 2x  |
|    |    |
| 3x   | 2x  |
|    |    |
| 1x   | 6x  |
|   |   |
| 2x   | 4x  |
|  |  |
| 1x   | 1x  |
|  |  |
| 2x   | 1x  |
|  |  |
| 1x   | 2x  |
|  |  |
| 6x   | 1x  |
|  |  |
| 3x   | 2x  |
|  |  |
| 1x   | 6x  |
|  |   |
| 2x   |   |
|  |   |
| 3x   |   |
|  |   |
| 1x   |   |
|  |   |
| 3x   |   |
|  |   |
| 1x   |   |
|  |   |
| 3x   |   |