

8

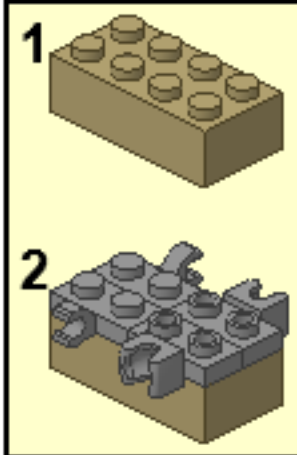

9

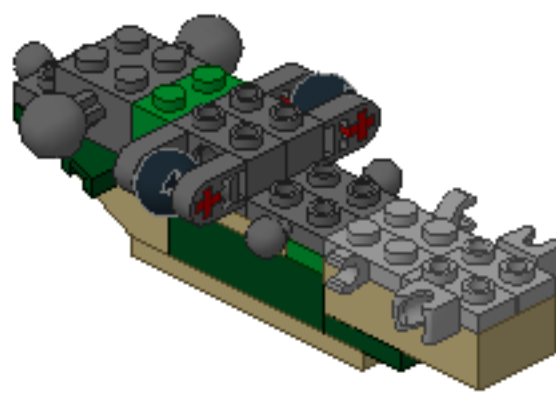
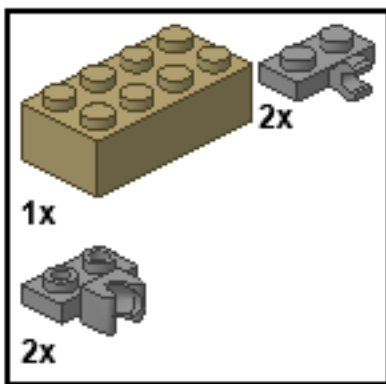
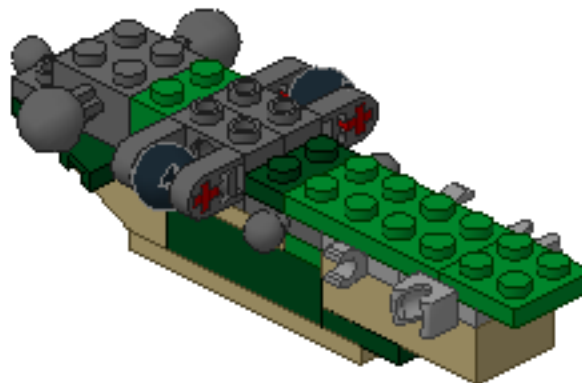
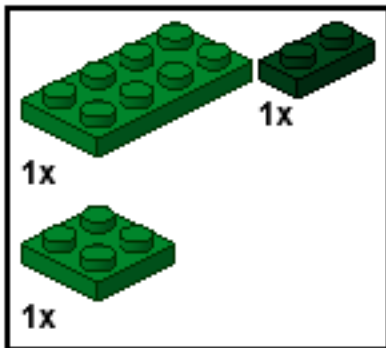

10

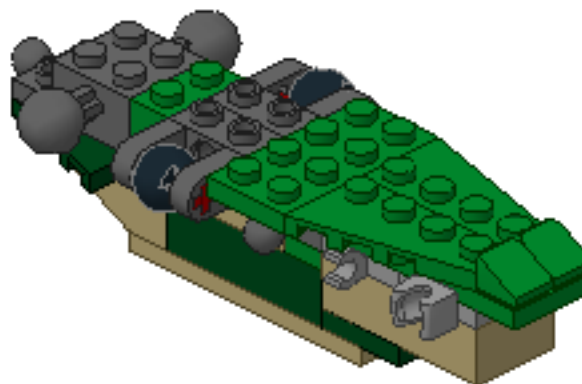
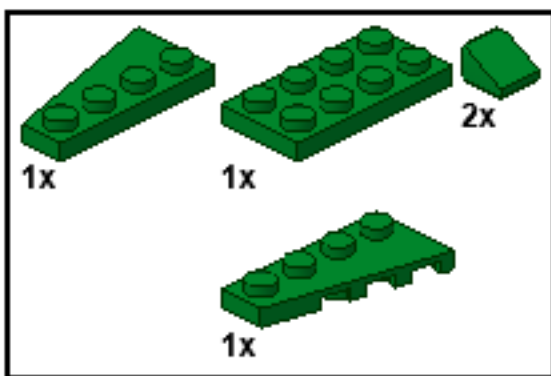

11

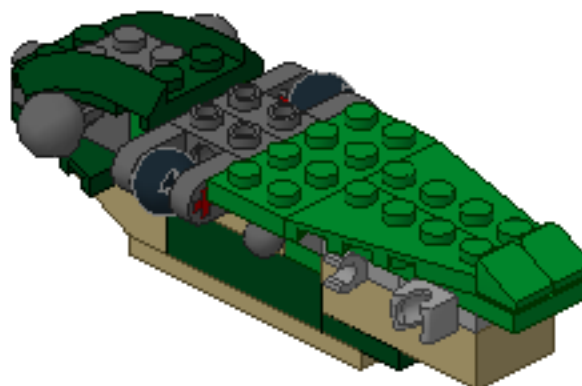
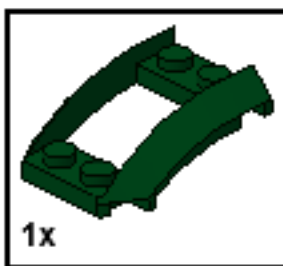

12

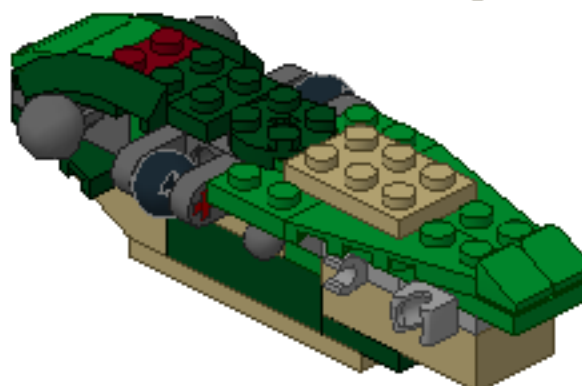
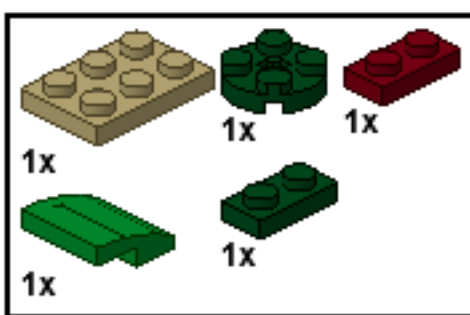

13

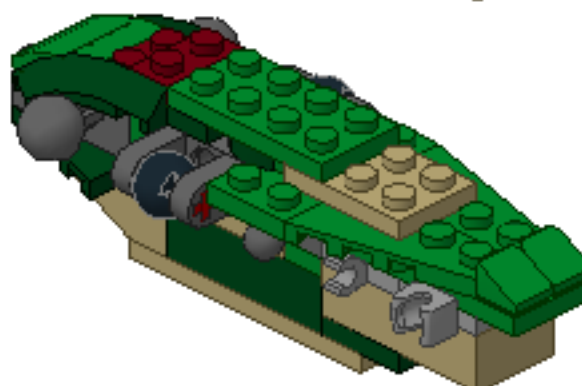
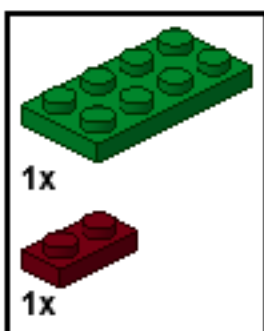

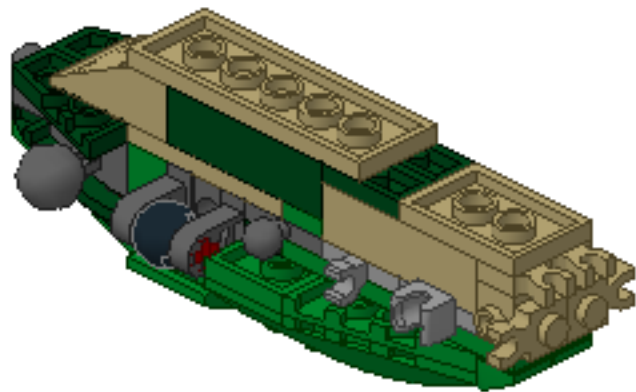
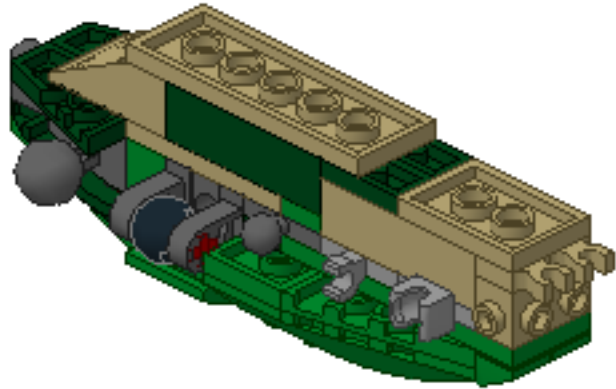
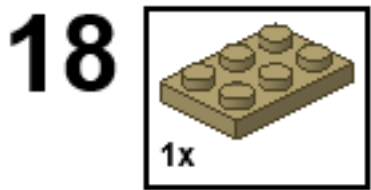
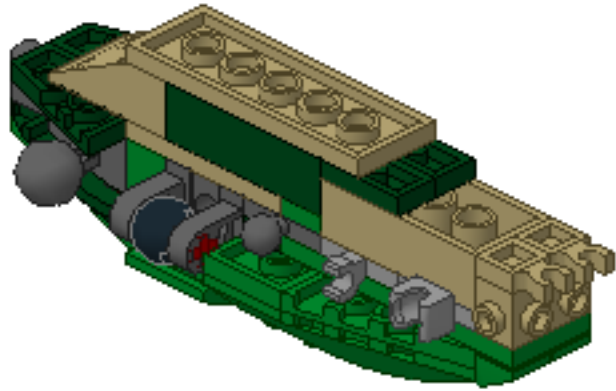
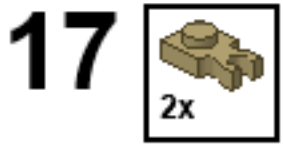
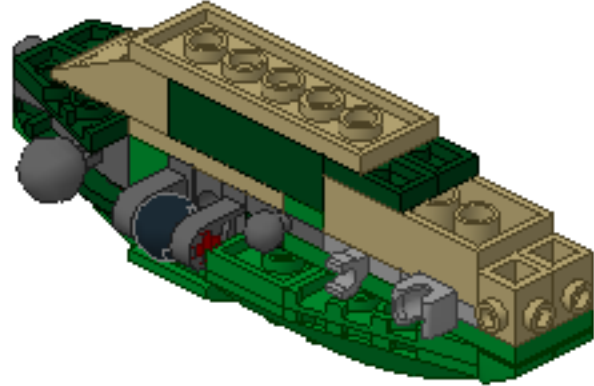
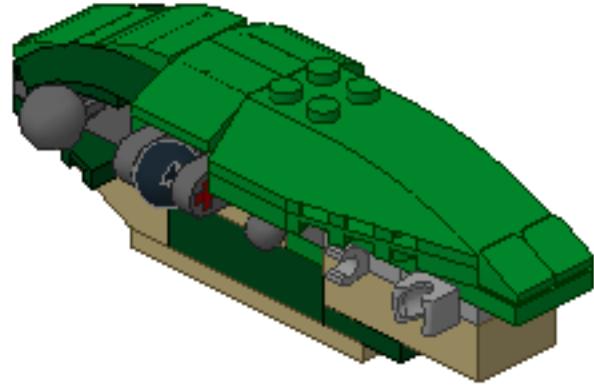
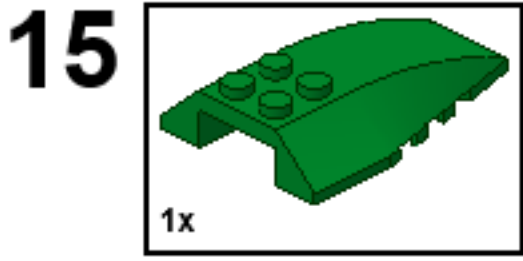
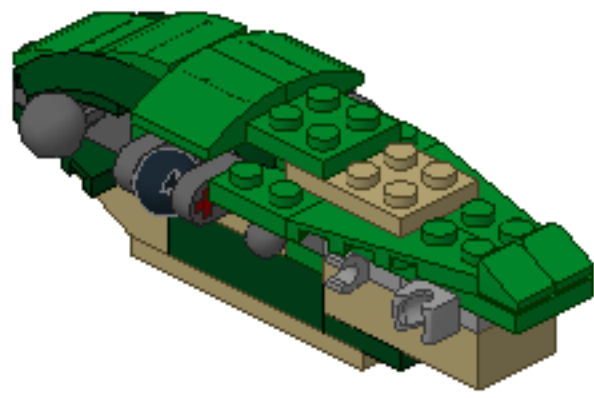

20  1x

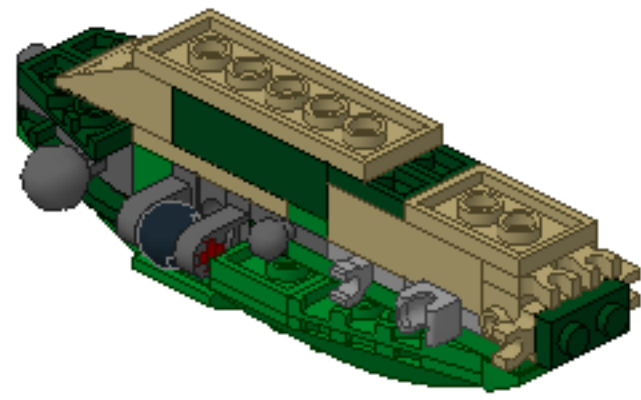

21  2x
 2x

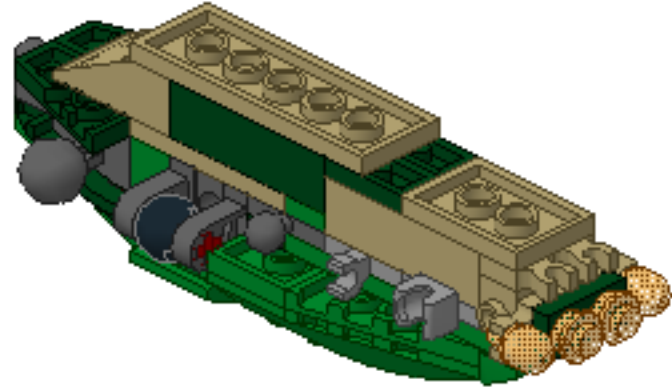

22  4x

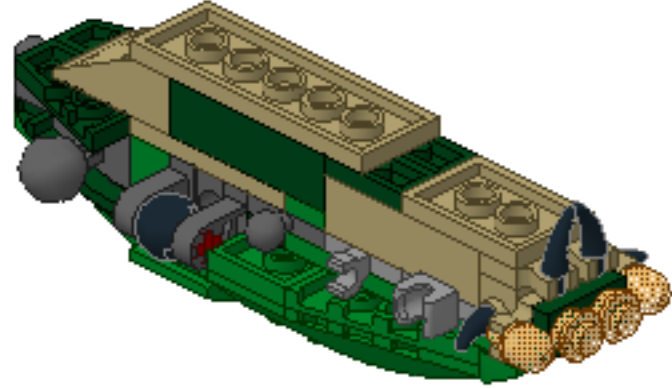

23

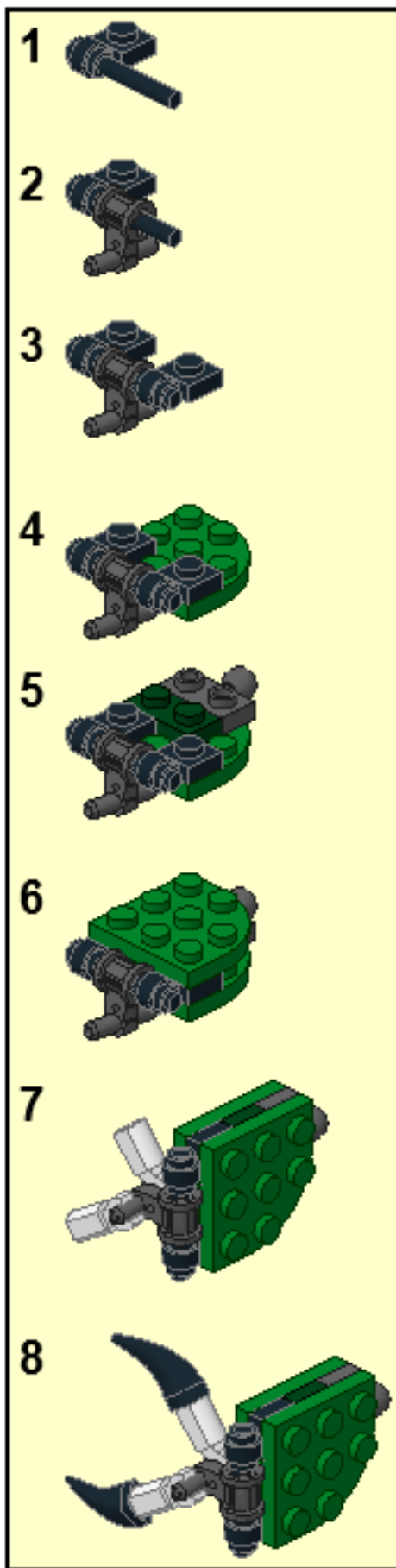
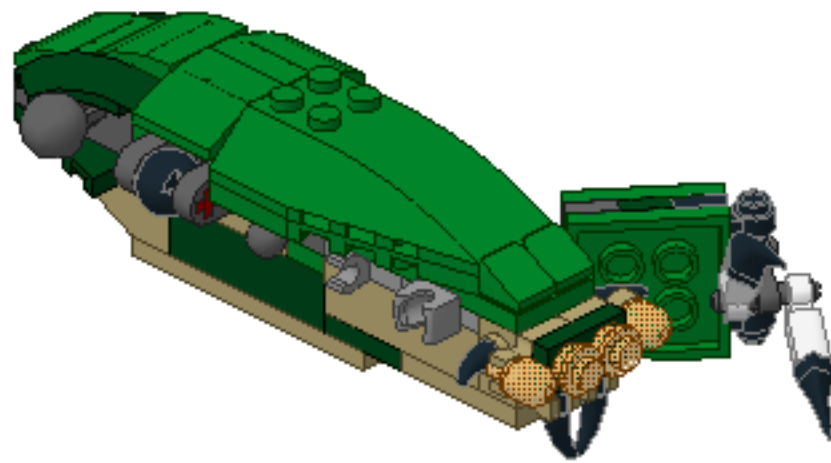
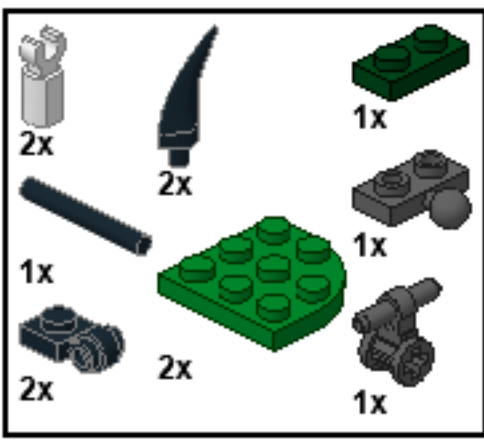

24

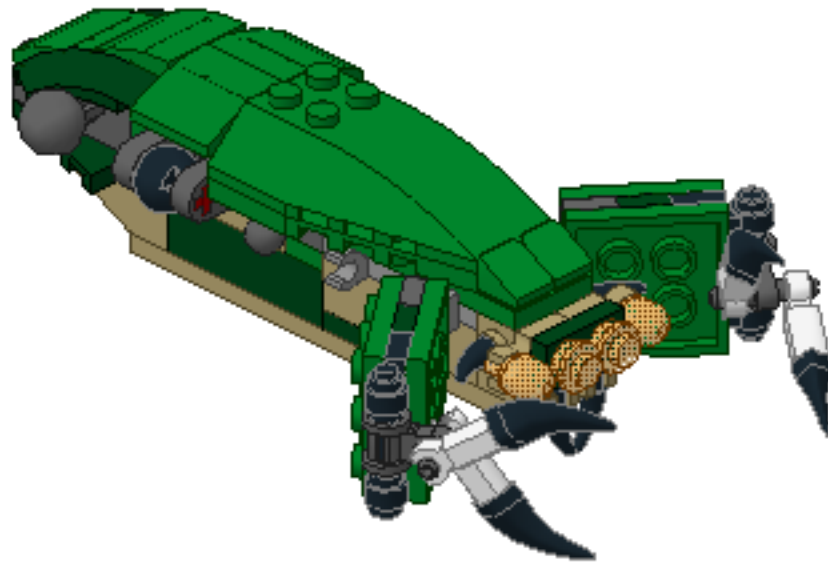
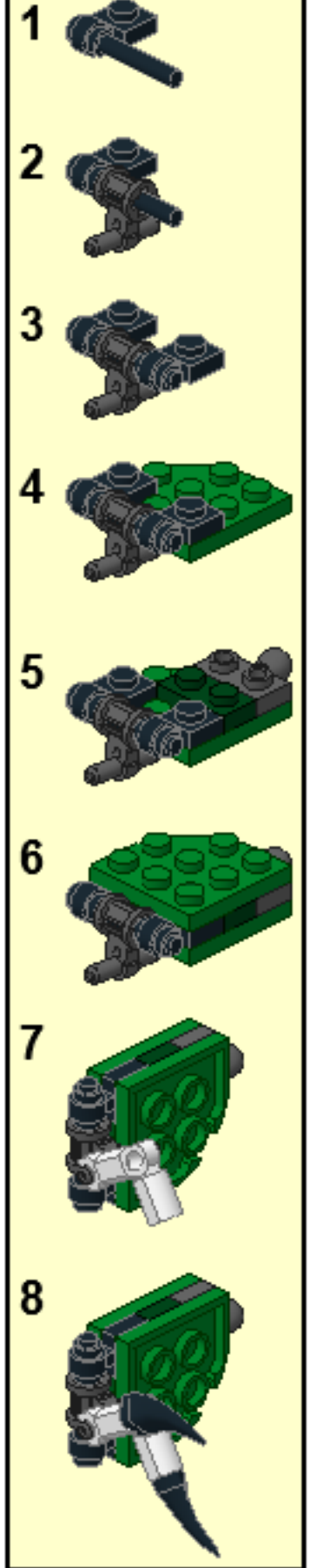
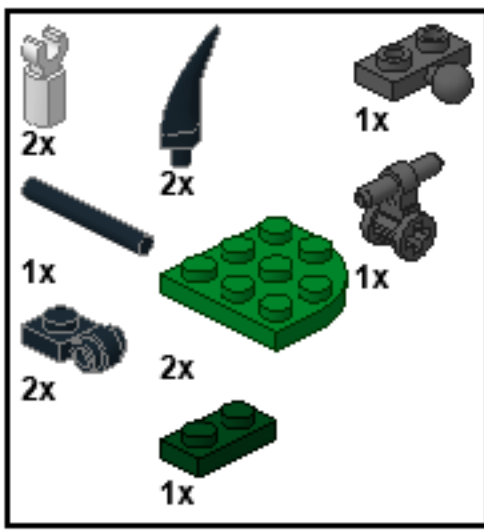

25

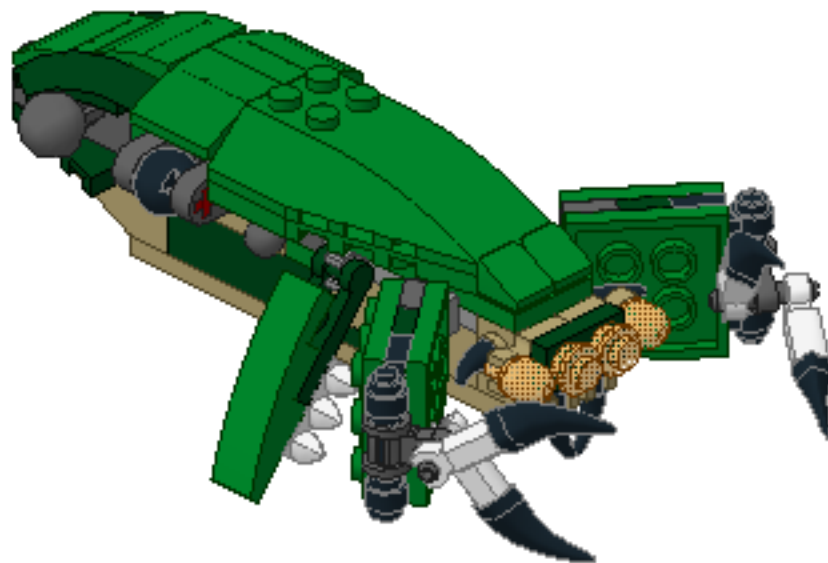
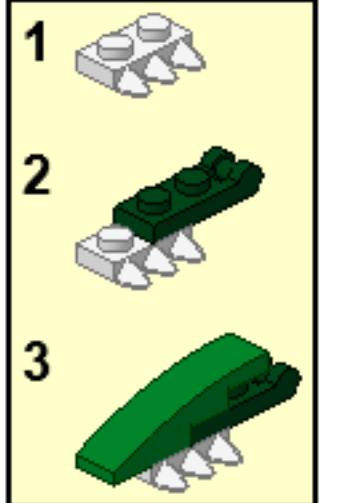
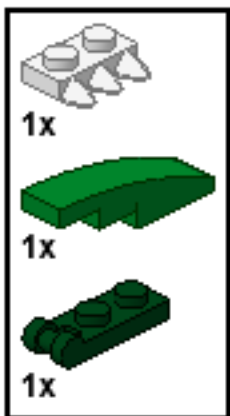

26

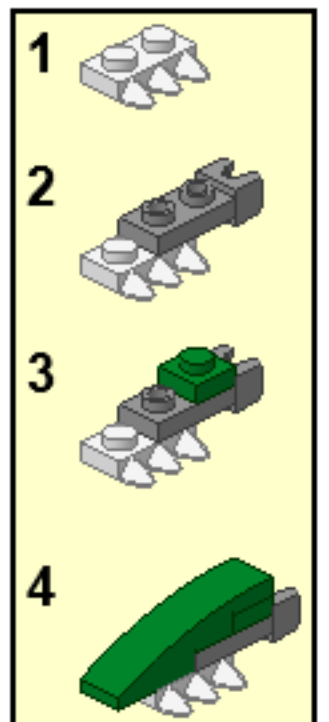
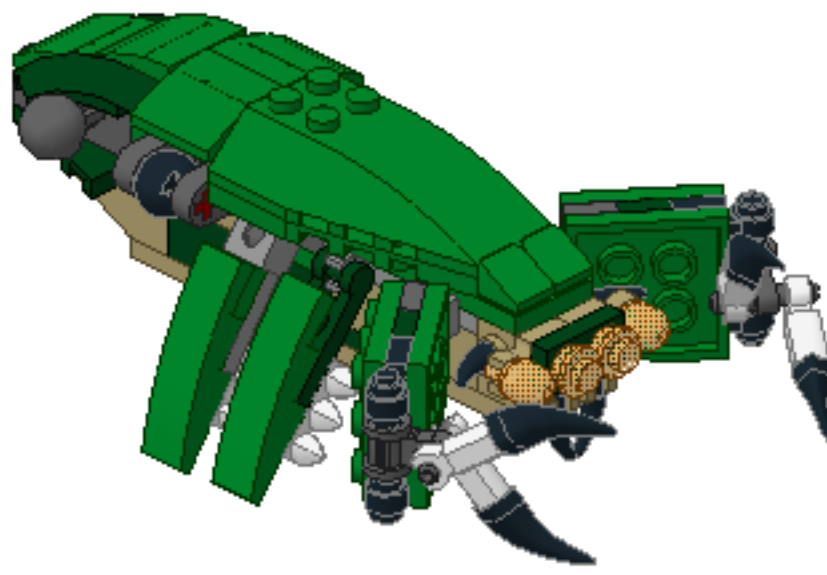
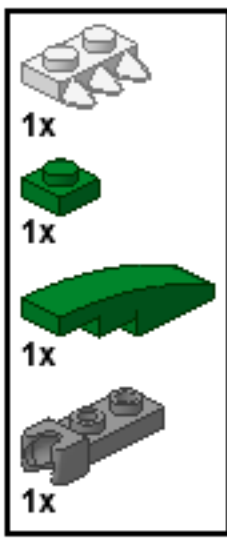

27

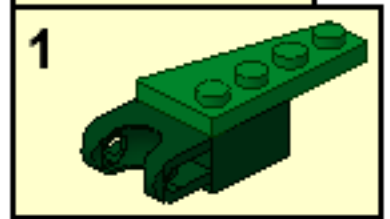
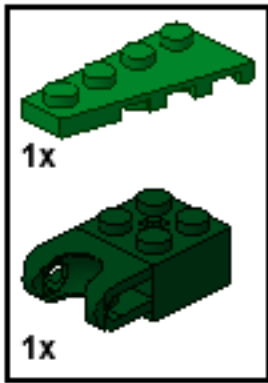

28

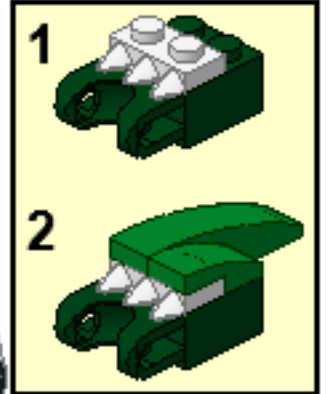
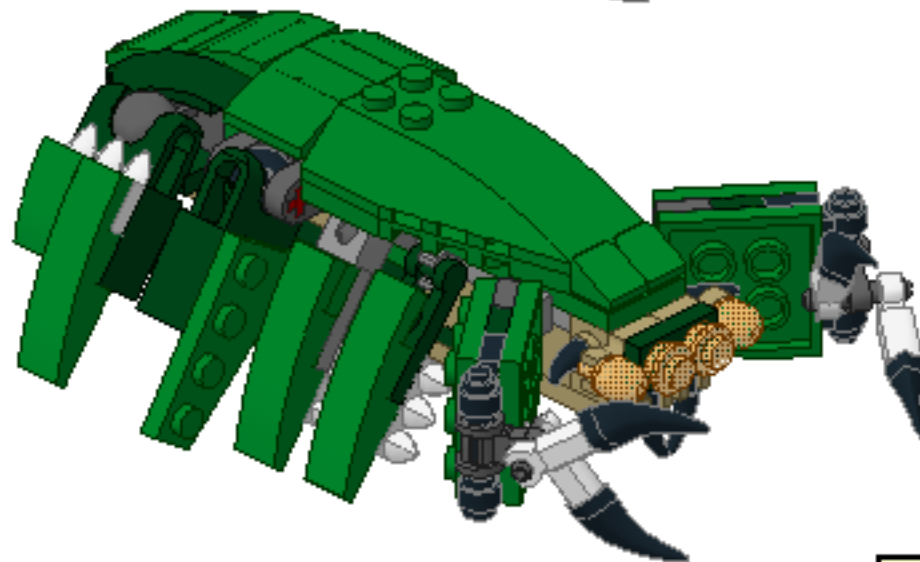
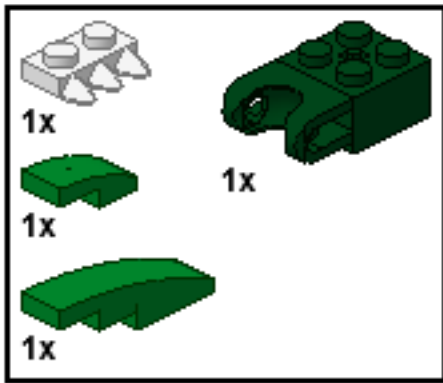

29

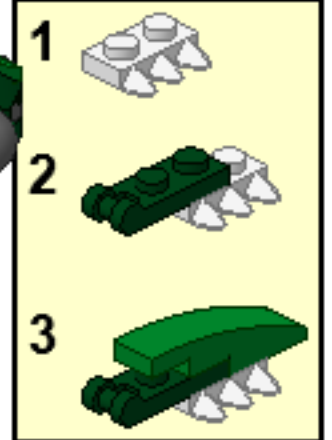
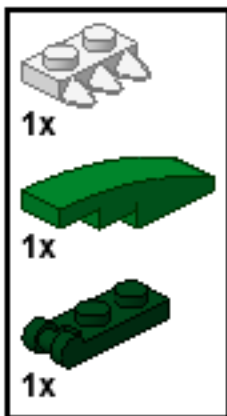

30

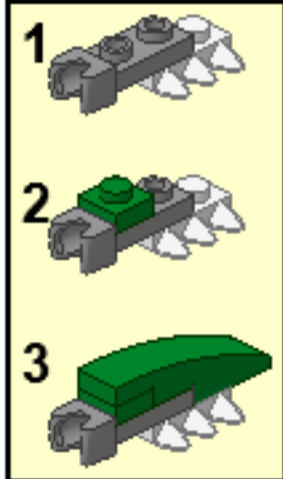
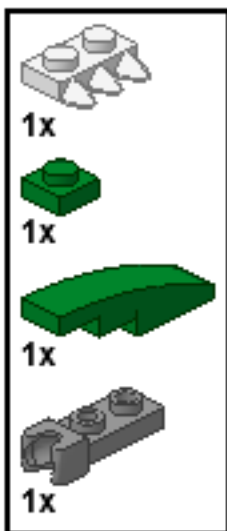

31

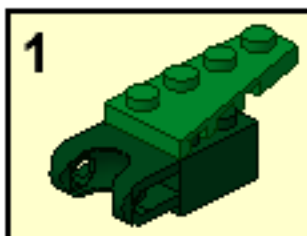
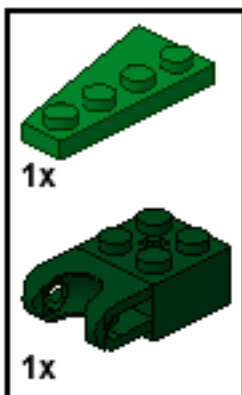

32

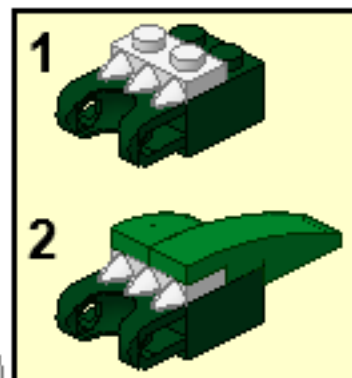
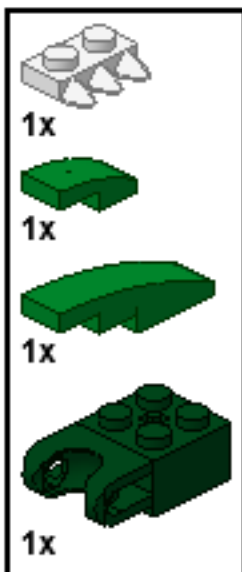

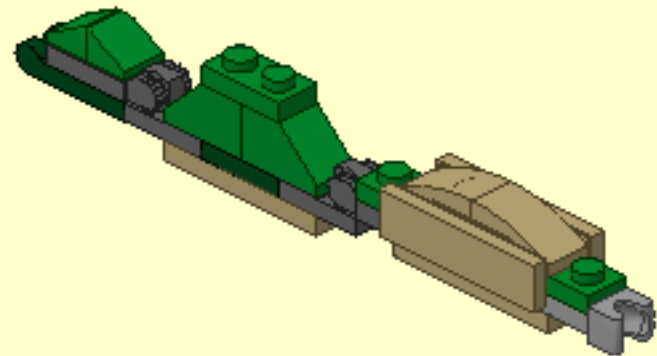
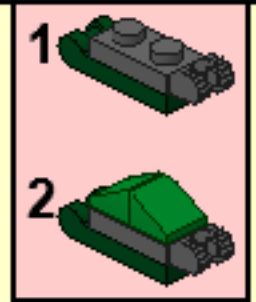
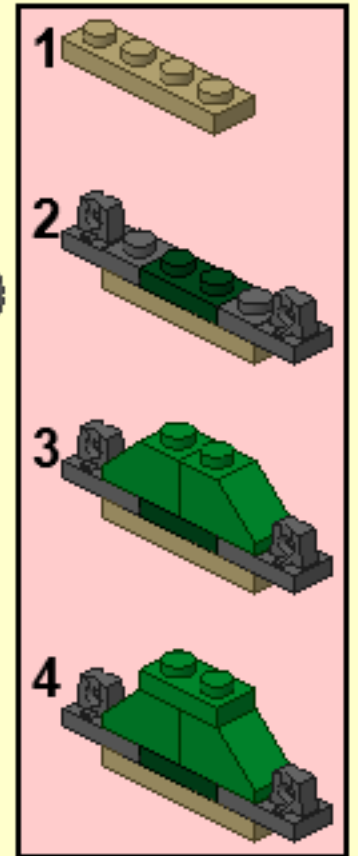
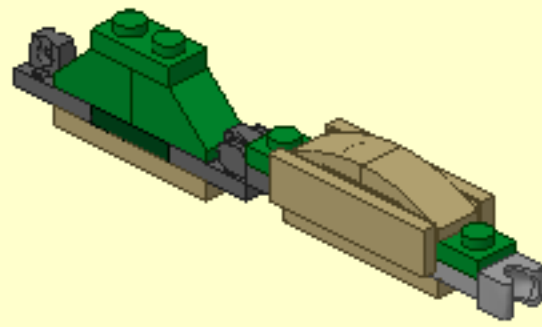
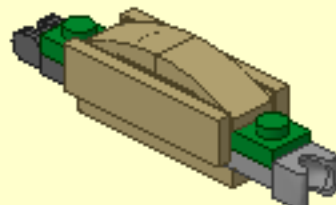
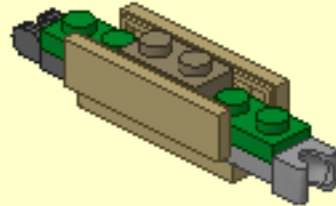
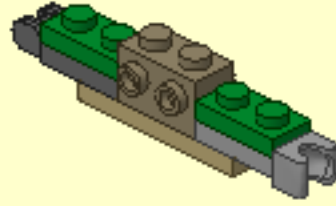
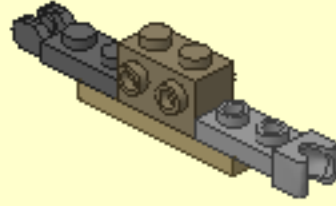
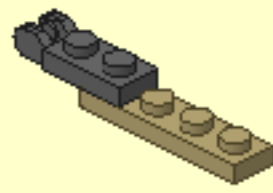
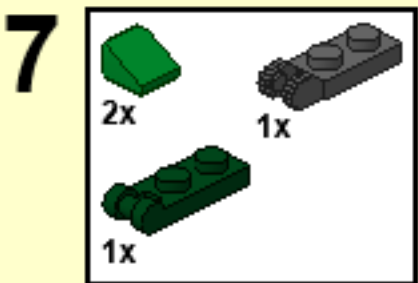
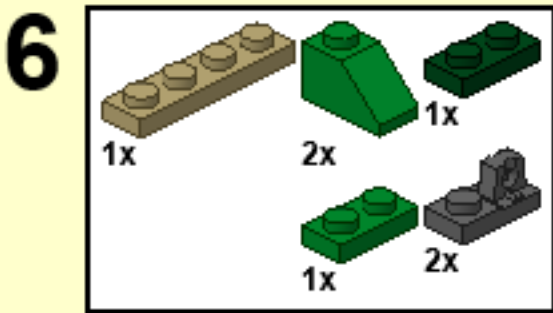
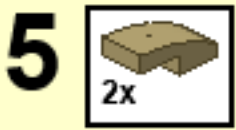
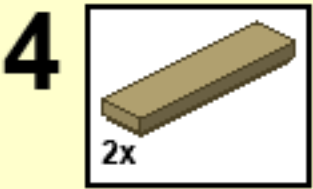
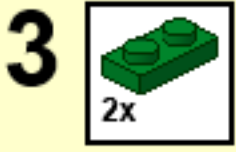
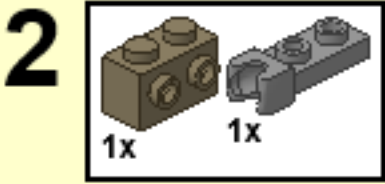
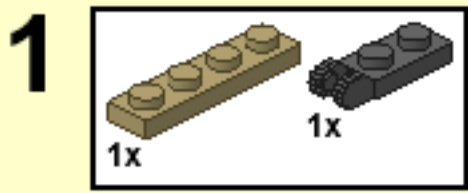

8

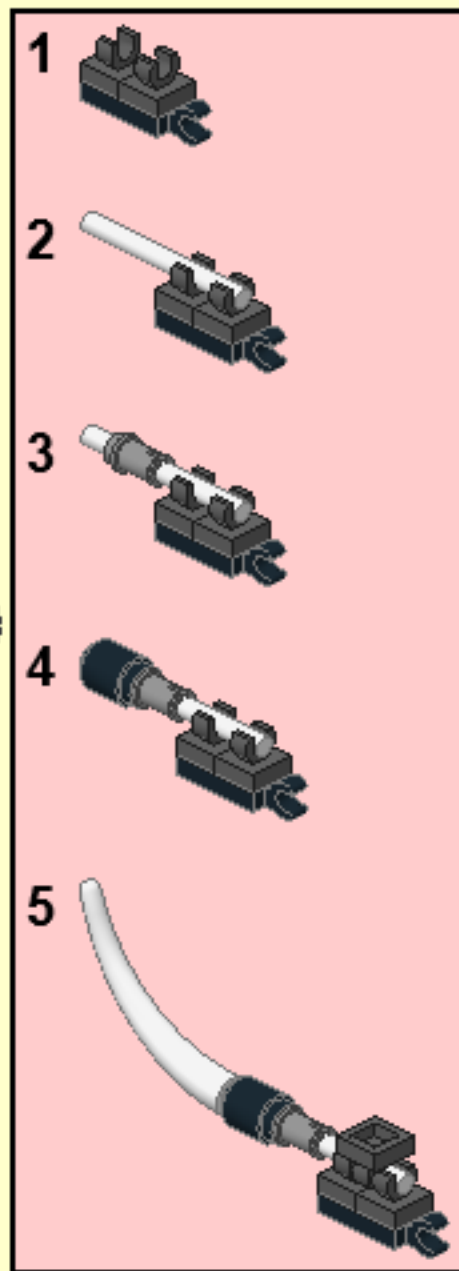
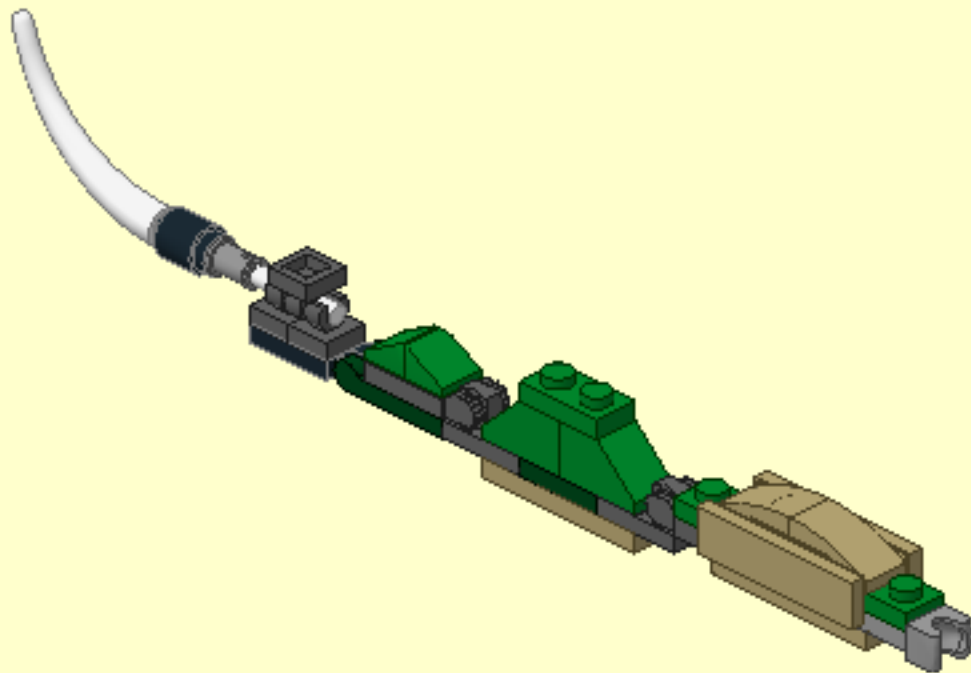
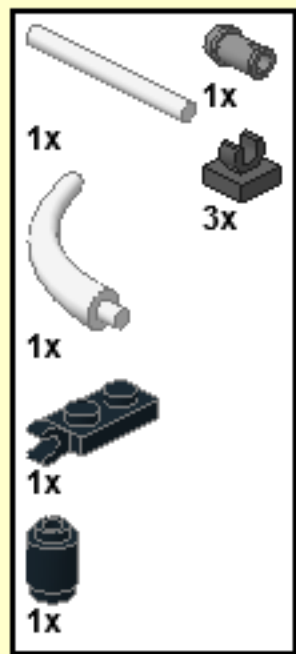

33

