

1

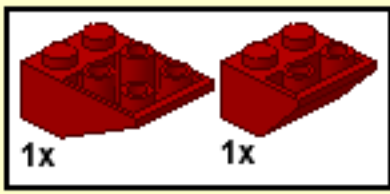

2

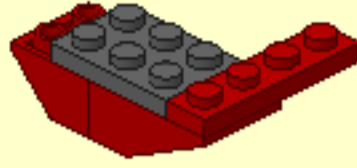
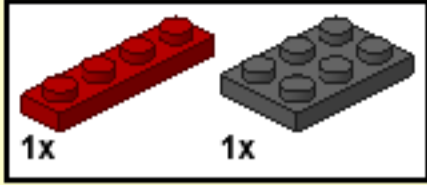

3

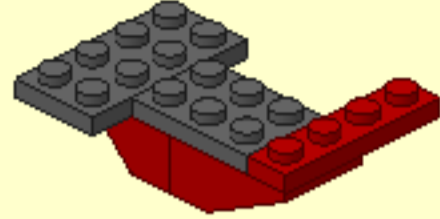
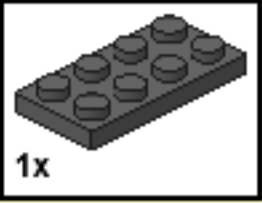

4

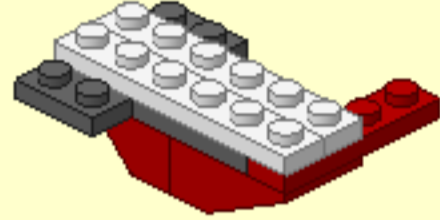
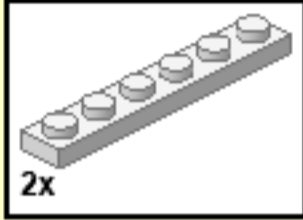

5



6

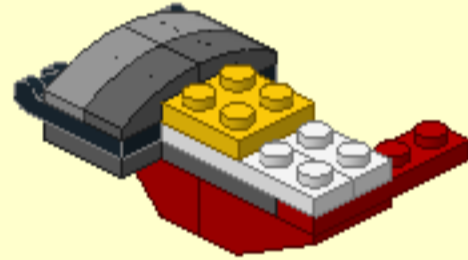
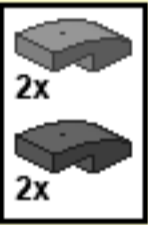

7

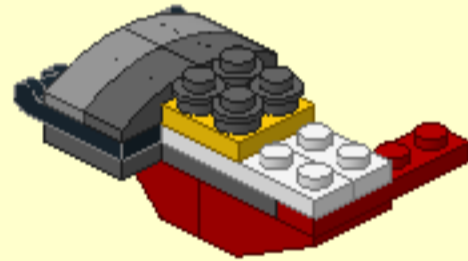

8

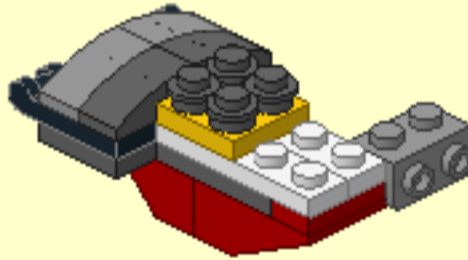

9

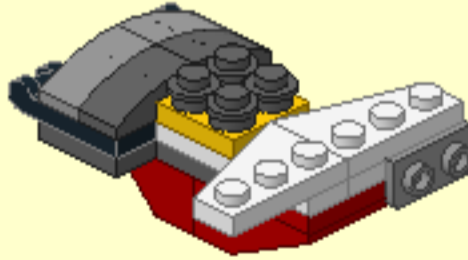
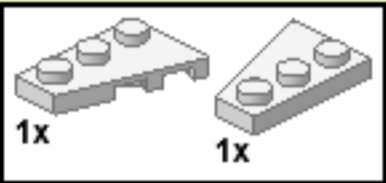

10

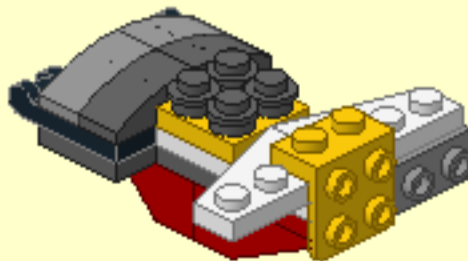

11  2x

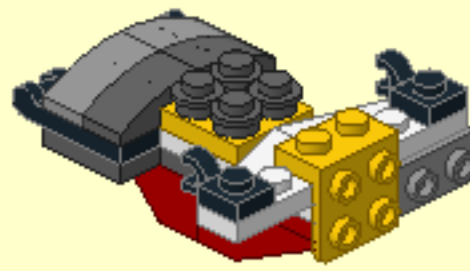

12  4x

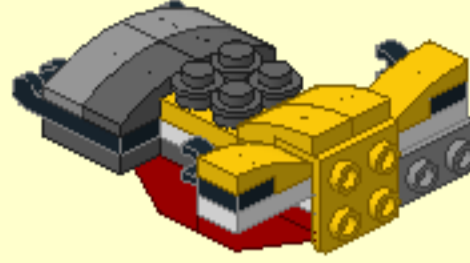

13  1x

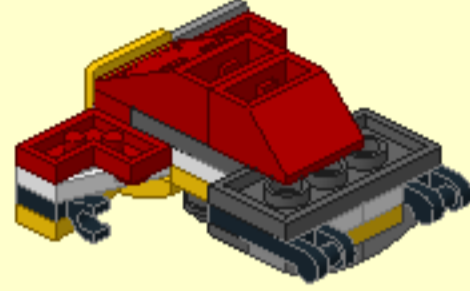

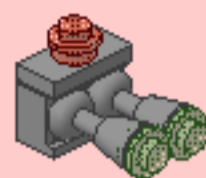
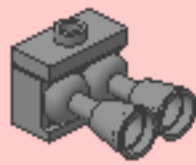
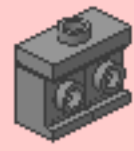
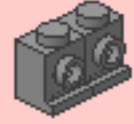

14

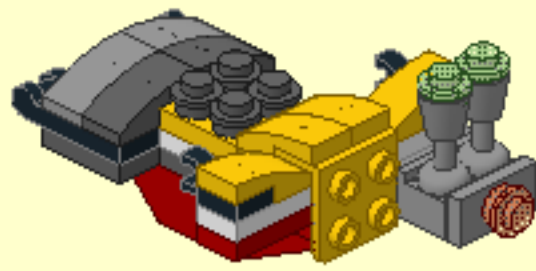
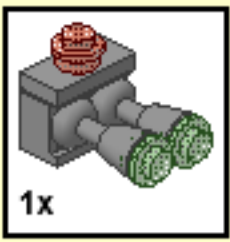

1

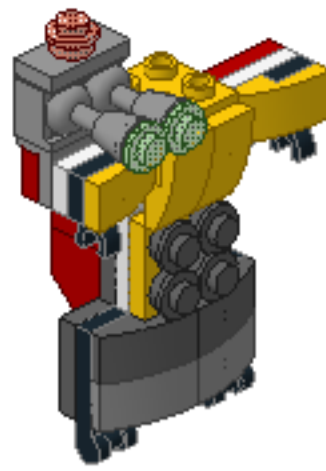
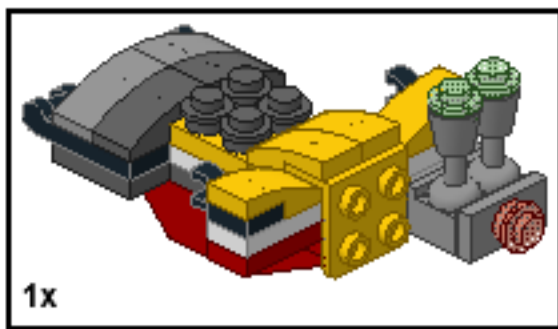

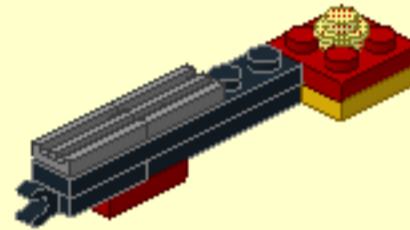
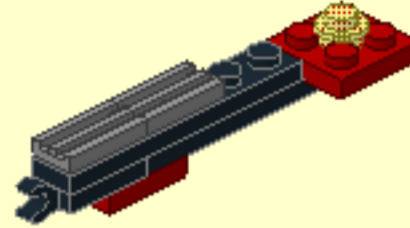
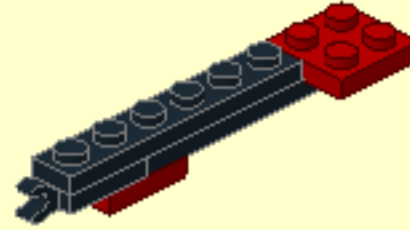
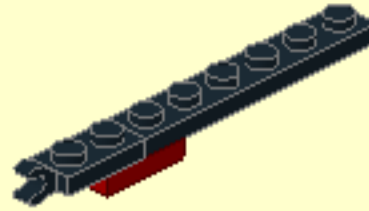
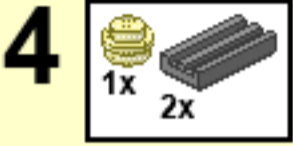
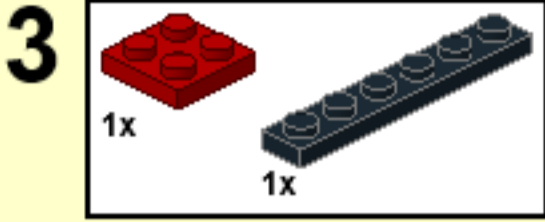
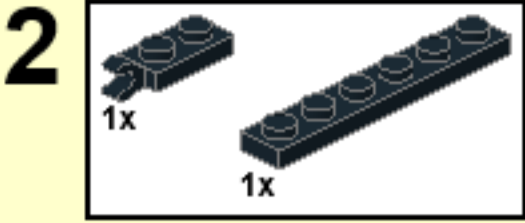

1



2

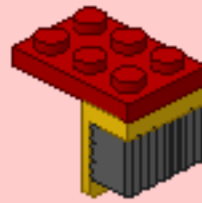
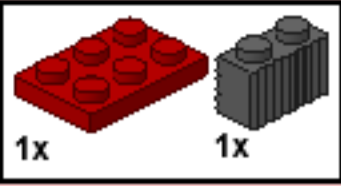

6

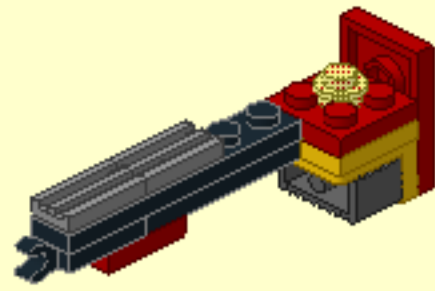
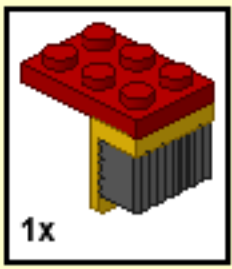



2

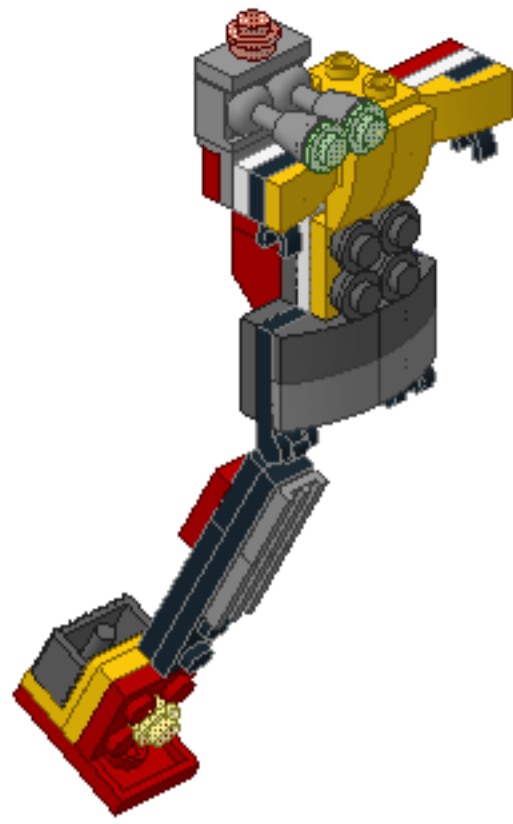
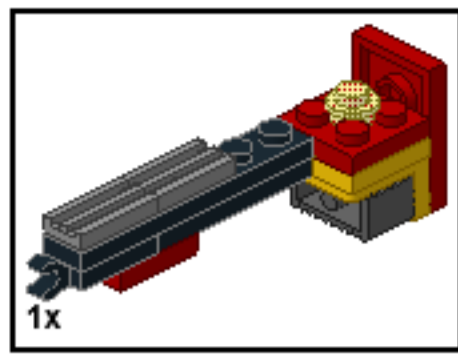

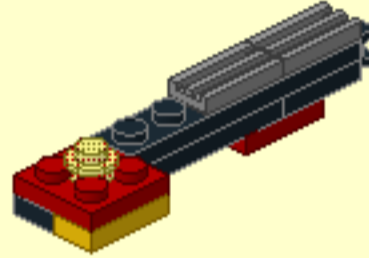
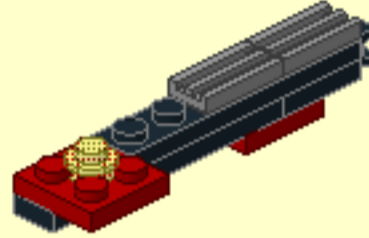
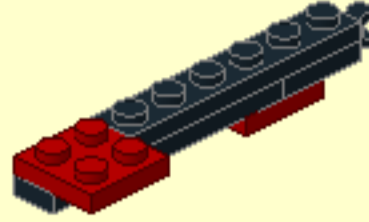
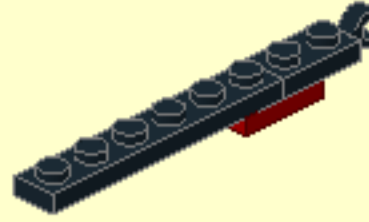
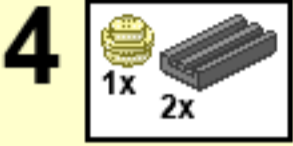
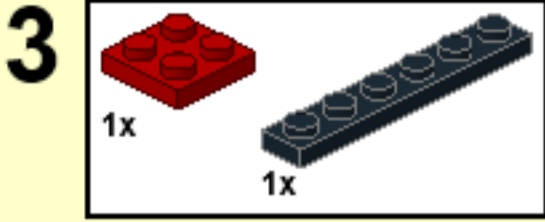
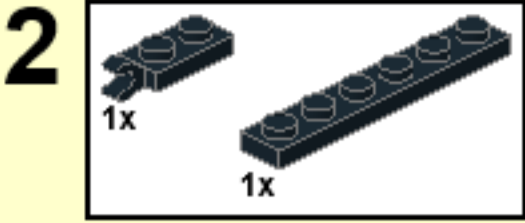

1

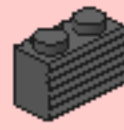
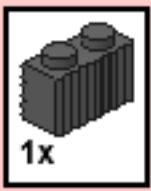

2



3

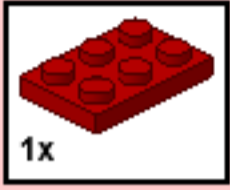

6

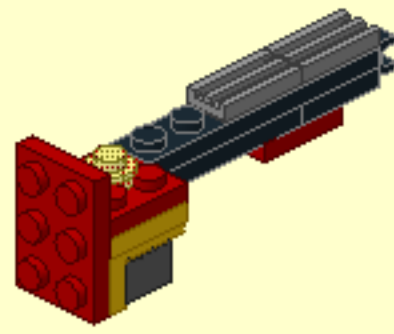

3

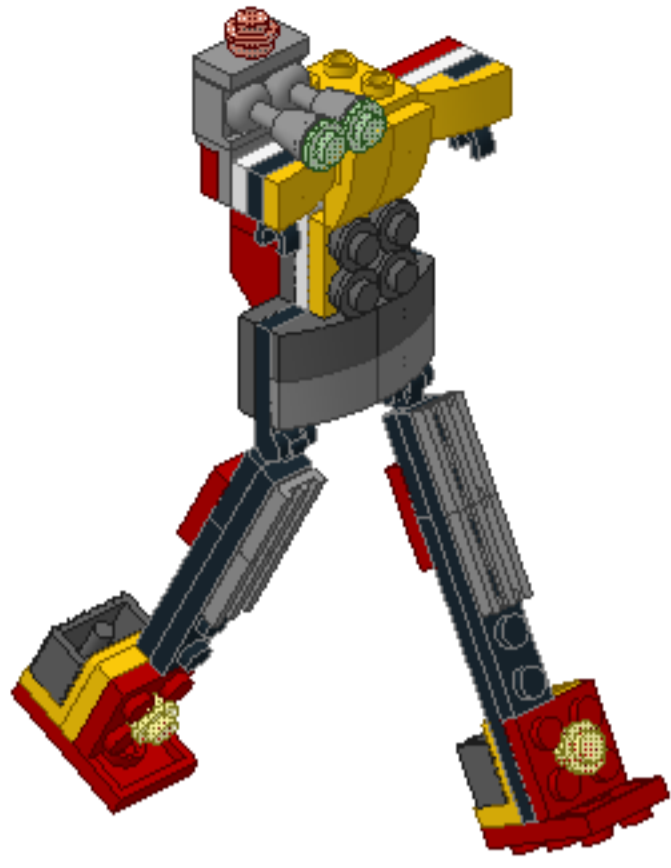
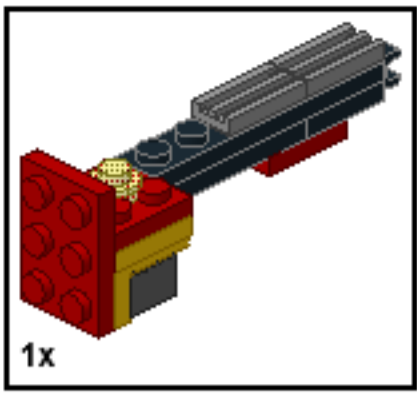

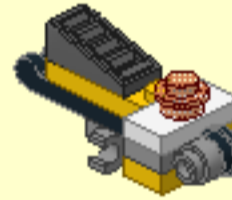
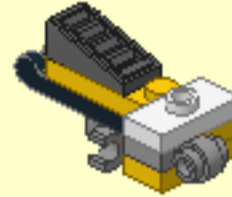
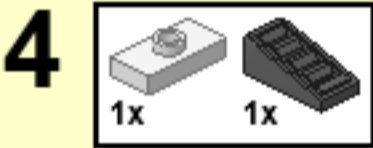
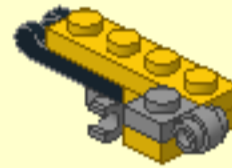
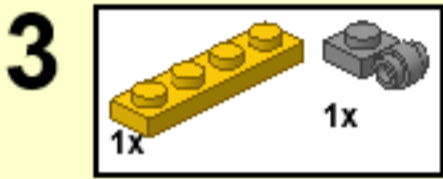

4

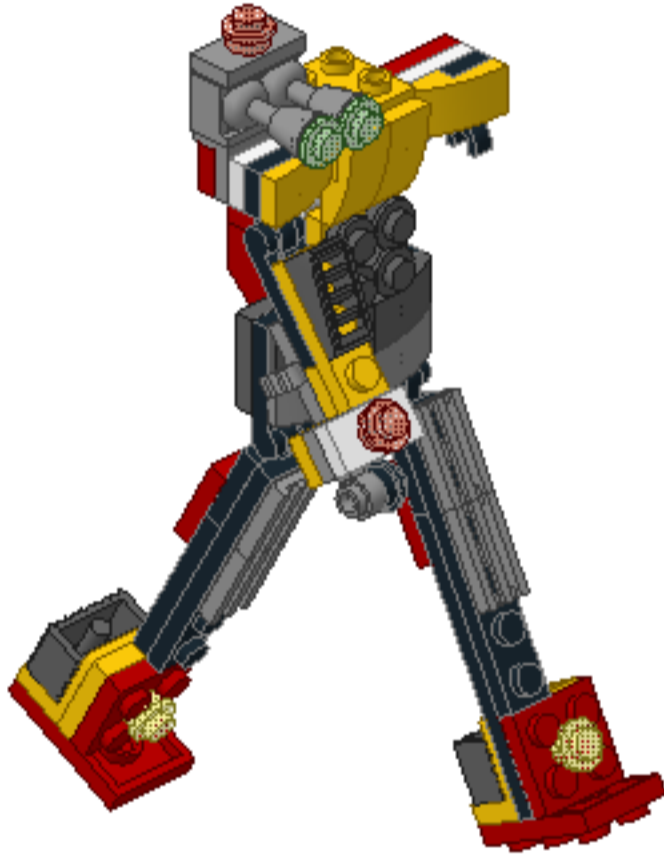
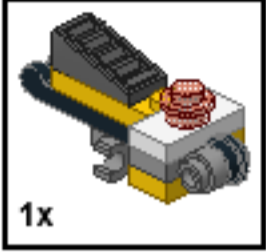

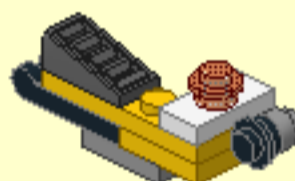
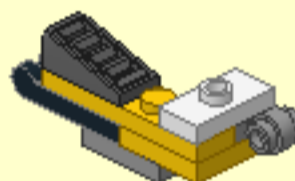
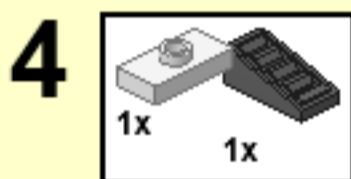
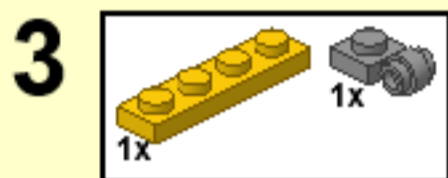
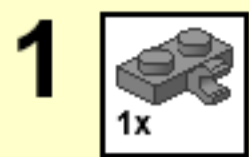



5

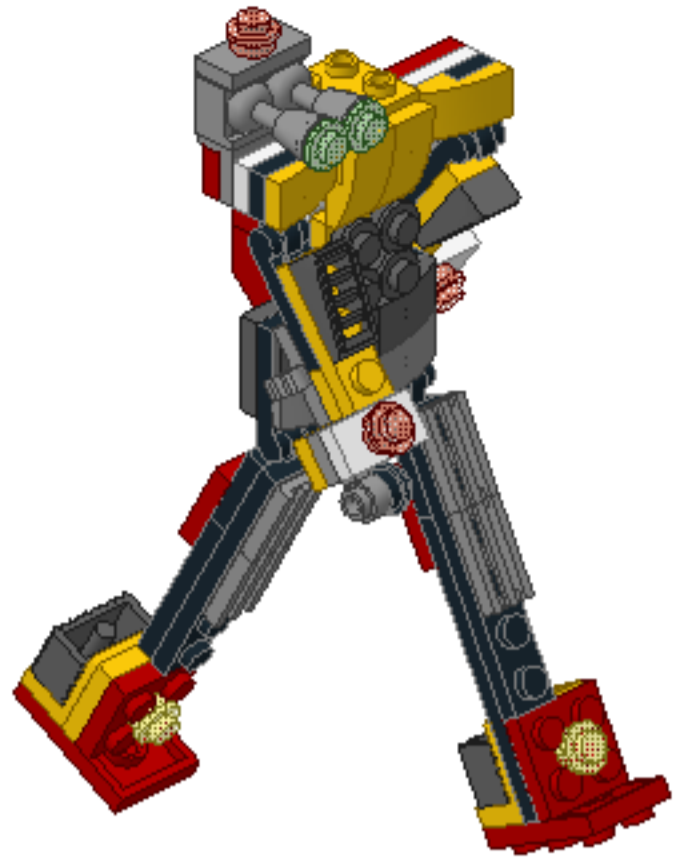
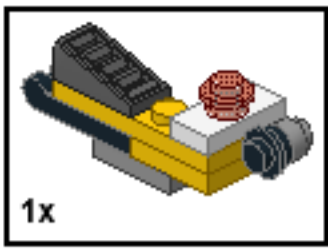

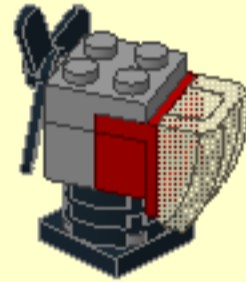
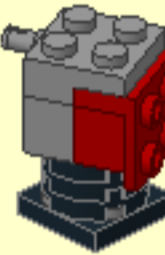
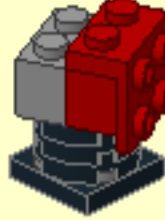
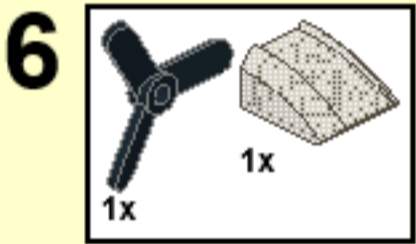
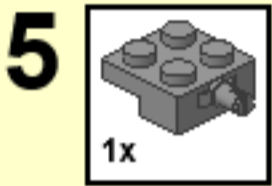
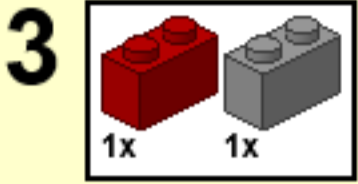
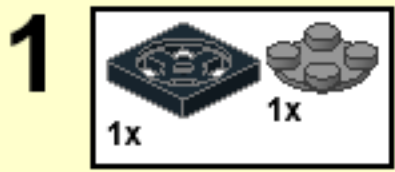

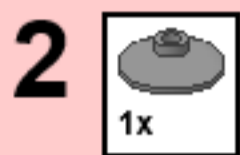
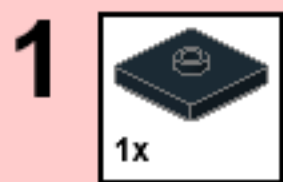

7

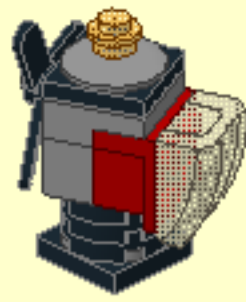

6

